

Installation, Operation, and Maintenance

C-Series Cassette Indoor Units

Models: 4MUC4518A10N0A, 4MUC4524A10NA, 4MUC4530A10N0A, 4MUC4536A10N0A, 4MUC4542A10N0A,
4MUC4548A10N0A

⚠ SAFETY WARNING

Only qualified personnel should install and service the equipment. The installation, starting up, and servicing of heating, ventilating, and air-conditioning equipment can be hazardous and requires specific knowledge and training. Improperly installed, adjusted or altered equipment by an unqualified person could result in death or serious injury. When working on the equipment, observe all precautions in the literature and on the tags, stickers, and labels that are attached to the equipment.

May 2015

MS-SVX039A-EN
DB68-05139A(1)

IR Ingersoll Rand

Introduction

Read this manual thoroughly before operating or servicing this unit.

Warnings, Cautions, and Notices

Safety advisories appear throughout this manual as required. Your personal safety and the proper operation of this machine depend upon the strict observance of these precautions.

The three types of advisories are defined as follows:

⚠ WARNING Indicates a potentially hazardous situation which, if not avoided, could result in death or serious injury.

⚠ CAUTION Indicates a potentially hazardous situation which, if not avoided, could result in minor or moderate injury. It could also be used to alert against unsafe practices.

NOTICE Indicates a situation that could result in equipment or property-damage only.

Important Environmental Concerns

Scientific research has shown that certain man-made chemicals can affect the earth's naturally occurring stratospheric ozone layer when released to the atmosphere. In particular, several of the identified chemicals that may affect the ozone layer are refrigerants that contain Chlorine, Fluorine and Carbon (CFCs) and those containing Hydrogen, Chlorine, Fluorine and Carbon (HCFCs). Not all refrigerants containing these compounds have the same potential impact to the environment. Trane advocates the responsible handling of all refrigerants-including industry replacements for CFCs such as HCFCs and HFCs.

Important Responsible Refrigerant Practices

Trane believes that responsible refrigerant practices are important to the environment, our customers, and the air conditioning industry. All technicians who handle refrigerants must be certified. The Federal Clean Air Act (Section 608) sets forth the requirements for handling, reclaiming, recovering and recycling of certain refrigerants and the equipment that is used in these service procedures. In addition, some states or municipalities may have additional requirements that must also be adhered to for responsible management of refrigerants. Know the applicable laws and follow them.

⚠ WARNING

Proper Field Wiring and Grounding Required!

Failure to follow code could result in death or serious injury. All field wiring **MUST** be performed by qualified personnel. Improperly installed and grounded field wiring poses **FIRE** and **ELECTROCUTION** hazards. To avoid these hazards, you **MUST** follow requirements for field wiring installation and grounding as described in NEC and your local/state electrical codes.

⚠ WARNING

Personal Protective Equipment (PPE) Required!

Failure to wear proper PPE for the job being undertaken could result in death or serious injury. Technicians, in order to protect themselves from potential electrical, mechanical, and chemical hazards, **MUST** follow precautions in this manual and on the tags, stickers, and labels, as well as the instructions below:

- Before installing/servicing this unit, technicians **MUST** put on all PPE recommended for the work being undertaken. **ALWAYS** refer to appropriate MSDS sheets and OSHA guidelines for proper PPE.
- When working with or around hazardous chemicals, **ALWAYS** refer to the appropriate MSDS sheets and OSHA guidelines for information on allowable personal exposure levels, proper respiratory protection, and handling recommendations.
- If there is a risk of arc or flash, technicians **MUST** put on all PPE in accordance with NFPA 70E or other country-specific requirements for arc flash protection, **PRIOR** to servicing the unit.

Copyright

This document and the information in it are the property of Trane and may not be used or reproduced in whole or in part, without the written permission of Trane. Trane reserves the right to revise this publication at any time and to make changes to its content without obligation to notify any person of such revision or change.

Trademarks

All trademarks referenced in this document are the trademarks of their respective owners.

Table of Contents

Model Number Description	4
Preparing for Installation	5
Accessories	5
Location Considerations	5
Unit Dimensions	6
Service Clearances	7
Installation	8
Mounting the Unit	8
Purging the Unit	9
Installing Refrigerant Piping	10
Leak Testing Pipe Connections	12
Installing the Drain System	13
Centralized Drainage	15
Testing the Drainage	15
Insulation	16
Refrigerant Pipes	16
Drainage Hose	16
Wiring the Unit	17
Power Wiring	17
Communications Wiring	17
Electrical Conduit Installation	19
Configuration	20
Using the Technician Utilities Tool (TUT)	20
Using the Wireless Remote Control	21
The 2-Digit Segments	22
Installation Option #1	23
Operation	25
Components	25
Operating Tips	25
Internal Protections	26
Operating Ranges	26
Cleaning the Exterior	26
Cleaning the Grill and Air Filter	27
Periodic Maintenance Checks	28
Troubleshooting	29
Warranty For Trane C-Series Ductless Systems and Related Accessories ...	31

Model Number Description

4	M	U	C	4	5	1	8	A	1	0	N	0	A
1	2	3	4	5	6	7	8	9	10	11	12	13	14

Digit 1: Refrigerant

4 = R-410A

Digit 2: Brand name

M = Mini-split indoor unit

Digit 3: System type

U = Universal match heat pump

Digit 4: Configuration type

C = 4-way cassette

Digit 5: Reserved for future use

4 = Standard model

Digit 6: Connection type

5 = Flare

Digit 7, 8: Nominal capacity (Btu/h x 1,000)

18 = 18,000 Btu/h	36 = 36,000 Btu/h
24 = 24,000 Btu/h	42 = 42,000 Btu/h
30 = 30,000 Btu/h	48 = 48,000 Btu/h

Digit 9: Major development sequence

A = First development sequence

Digit 10: Electric power supply characteristics

1 = 208–230/60/1

Digit 11: Reserved for future use

0 = Not currently used

Digit 12: Region of sale

N = North America (UL or ETL)

Digit 13: Reserved for future use

0 = Not currently used







Digit 14: Minor design sequence

A = First design sequence

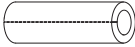
Preparing for Installation

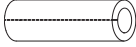
Accessories

In addition to product literature, the following accessories are supplied with this unit. The type and quantity may differ, depending on the model.

Template	Insulation A	Insulation B	Insulation C	Flexible hose clamp	Flexible hose	Cable tie	Conduit bracket
							

Note: The required panel is not included with the indoor unit. It must be ordered separately (Model #TVEPANPC4NUSET).

Location Considerations

When deciding on a location for the indoor unit, the following factors must be considered:

- The air inlet and outlet must be unobstructed.
- The wall or ceiling must support the weight of the unit.
- The wall or ceiling must not be subject to vibration.
- Pre-plan for easy and short routing of the refrigerant tubing and wiring to the outdoor unit.
- The air must circulate freely in the area to be cooled/heated.
- Sufficient clearance must be maintained around the unit.
- Condensate must be managed correctly and safely away from the unit.
- The unit should be installed in a way that prevents unauthorized access.
- The unit must not be installed in an area that is damp or could come into contact with water (such as a laundry room).
- The unit must not be exposed to direct sunshine or to other direct heat sources.
- The filter must be able to be removed and cleaned easily.
- The unit should be placed as far as possible from fluorescent lights so the remote control is not subject to interference.
- Care should be taken to prevent harmonics generated by loose or unsupported material in close proximity to a running unit.
- The unit must not be installed in an area that is exposed to salt, machine oil, sulfide gas, or corrosive environmental conditions.

Preparing for Installation

Unit Dimensions

Unit: inch (mm)

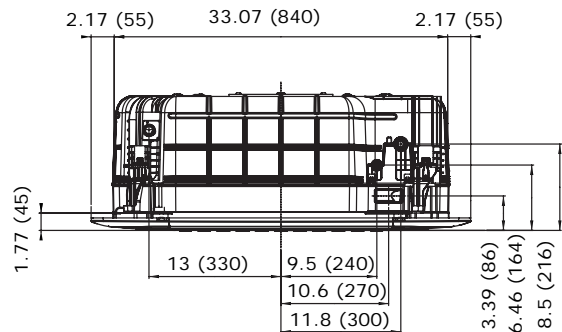
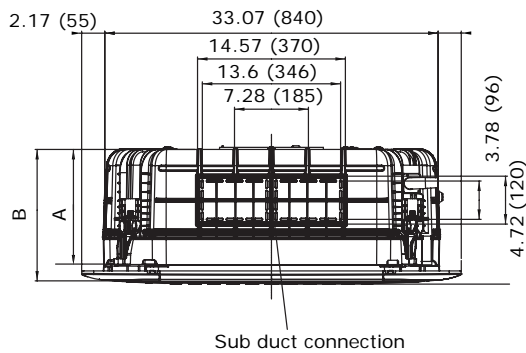
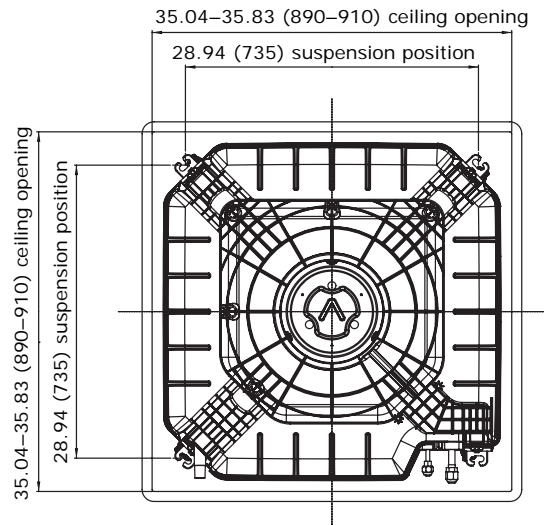
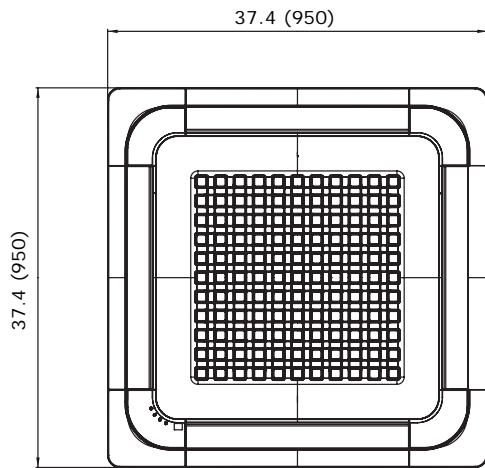

Dimension/Weight/Diameter	Model		
	4MUC4518A10N0A	4MUC4524A10N0A	4MUC4530A10N0A 4MUC4536A10N0A 4MUC4542A10N0A 4MUC4548A10N0A
A	8 (204)		11.3 (288)
B	10 (253)		13.3 (337)
Net dimension	33 x 8 x 33 (840 x 204 x 840)		33 x 11.3 x 33 (840 x 288 x 840)
Net weight	34.2 lb (15.5 kg)		41.9 lb (19 kg)
Liquid pipe connection	1/4 (6.35)	1/4 (6.35)	3/8 (9.52)
Gas pipe connection	1/2 (12.70)	5/8 (15.88)	5/8 (15.88)
Drain hose connection	OD: 0.98 (25), ID: 0.79 (20)		

Service Clearances

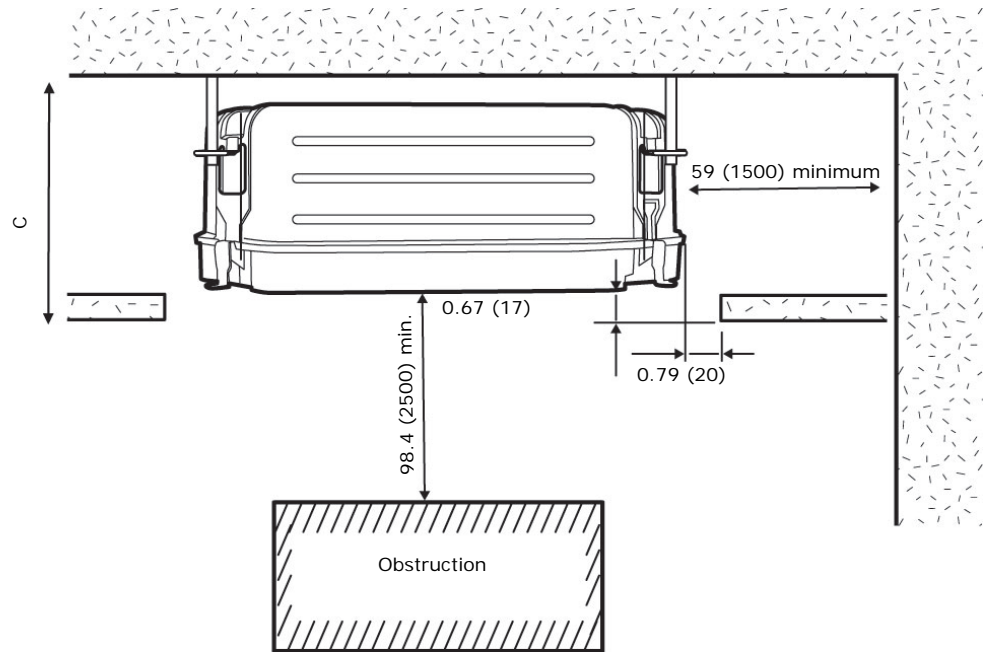

Clearance	Model	
		4MUC4518A10N0A 4MUC4524A10N0A
C	10 (253)	13.3 (337)

Installation

Review "Installation Considerations" before proceeding with installation.
Follow the procedures in these sections in the order given.

Mounting the Unit

If the ceiling is already constructed, piping must be laid into position before placing the unit inside the ceiling.

⚠ CAUTION

Avoid equipment damage and personal injury!

Ensure that the ceiling is strong enough to support the weight of the indoor unit. Before hanging the unit, test the strength of each of the attached suspension bolts.

To mount the unit:

1. Place the template on the spot where the unit is to be installed and mark the holes.

Note: *The template may shrink or stretch slightly due to heat or humidity. Before drilling holes, verify proper dimensions between the marks. Refer to "Installing the Front Panel" for final finishing clearances.*
2. Determine the appropriate type of suspension bolts and anchors according to the ceiling type. Insert bolt anchors into existing ceiling supports (A) or construct a suitable support (B).

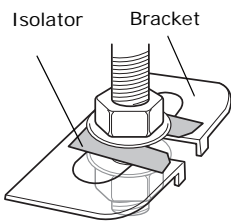
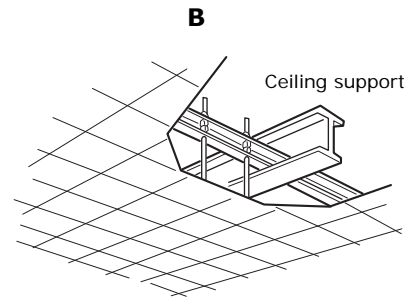
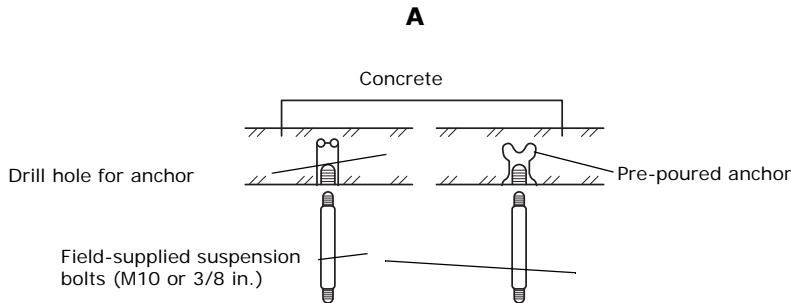

3. Install suspension bolts at all four locations.
4. Screw two nuts to each suspension bolt, leaving space between the nuts for hanging the unit.

Note: *If the suspension bolts are longer than 59 in. [1.5 m] or vibrations are a concern, place isolators on the brackets to absorb vibrations.*
5. Hang the unit by its support brackets between the two nuts.
6. If pad stoppers or isolators are used to absorb vibrations, place them on the brackets.
7. Tighten the nuts to suspend the unit following the guidelines in the figure below.

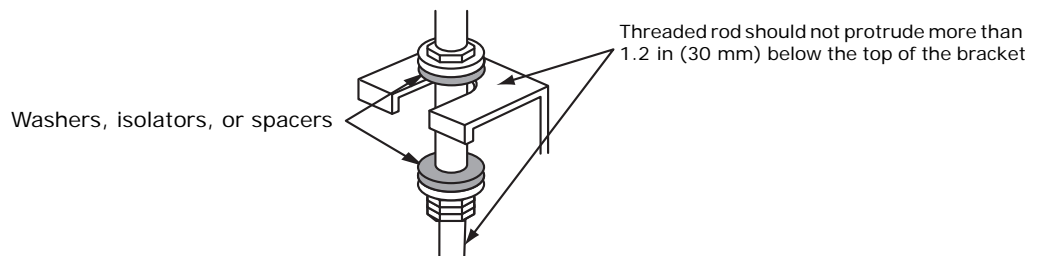

8. Maintain proper spacing between the unit and the ceiling; refer to the following figure.

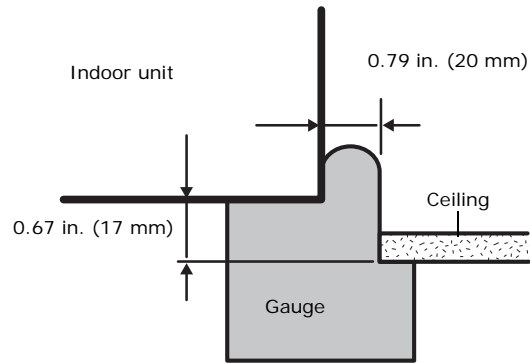

9. Adjust the level of the unit with a leveler.

Purging the Unit

The unit is shipped from the factory with a holding charge of nitrogen. All of this gas must be purged from the unit.

To purge the unit, unscrew the pinch pipes from the ends of both gas and liquid refrigerant pipes. Make sure all gas has escaped before connecting the piping.

Note: To prevent dirt or foreign objects from getting into the pipes during installation, do not remove the pinch pipes completely until you are ready to connect the piping.

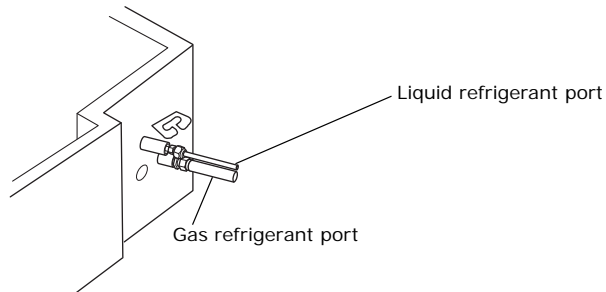

Installing Refrigerant Piping

Connect field-supplied piping using flared connections (not supplied) or by brazing. The large unit port is for gas refrigerant; the small one is for liquid refrigerant.

Cut or extend field-supplied piping as needed. Use the following procedures.

NOTICE

System Failure!

If brazing is used for pipe connections, a nitrogen purge is required to prevent the formation of copper oxides inside the piping. Failure to follow this procedure could damage the system.

- Before connecting the pipes, make sure they are free of dirt and debris.
- Use insulated, unwelded, degreased, and deoxidized copper pipe (Cu-DHP type according to ISO 1337 or UNI EN 12735-1) suitable for an operating pressure of at least 609.15 psi (4200 kPa) and a burst pressure of at least 3002.28 psi (20,700 kPa). Copper pipe for hydro-sanitary applications is unsuitable.
- For sizing and limits (height difference, line length, maximum bends, refrigerant charge, and so on) see the outdoor unit installation manual.
- All refrigerant connections must be accessible for servicing and maintenance.

Pipe Cutting

Required tools:

- Pipe cutter
- Reamer
- Pipe holder

1. Using a pipe cutter, cut the pipe so that the cut edge is at 90° to the side of the pipe.
2. Use a reamer to remove all burrs at the cut edge.

See examples of correctly and incorrectly cut pipes.

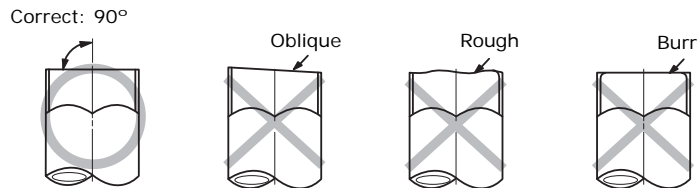

Flared Pipe Connections

Clutch type and wing nut type flare tools are available for flared pipe connections.

1. Slide the flare nut over the pipe to be flared.
2. Slide the end of the pipe into the hole on the flaring bar that fits the pipe, leaving a length of pipe, determined by tool type (see table), extending above the flaring bar. Clamp it down.

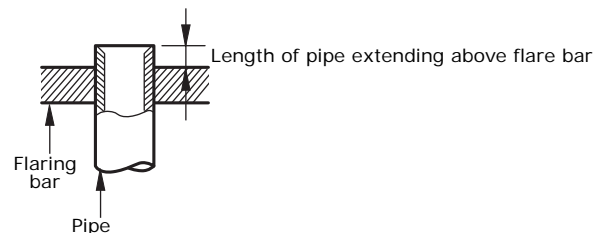

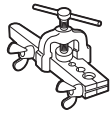
R-410A clutch type	Conventional flare tool	
	Clutch type	Wing nut type
0–0.020 in.	0.04–0.06 in.	0.06–0.08 in.
		

- Attach the yoke to the flaring bar, centering the conical part over the end of the pipe that is extending above the flaring bar.
- Tighten the yoke securely to flare the end of the pipe.

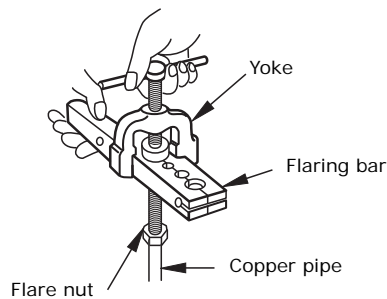

- Remove the pipe. The end of the pipe that you flared should look like the end of a trumpet. See examples of correctly and incorrectly flared pipes.

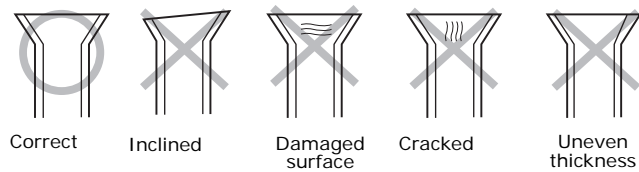

- Align the pipes and tighten the flare nuts manually and then with a spanner torque wrench, applying the torque according to pipe dimensions:

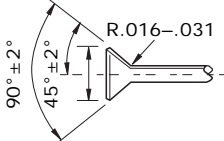
Outer diameter (in. [mm])	Connection torque (ft·lb)	Flare dimension (in.)	Flare shape (in.)
1/4 (6.35)	10.3–13.3 ft·lb	0.34–0.36	
3/8 (9.52)	25.1–31.0 ft·lb	0.50–0.52	
1/2 (12.70)	36.1–45.0 ft·lb	0.64–0.65	
5/8 (15.88)	50.2–60.5 ft·lb	0.76–0.78	

Leak Testing Pipe Connections

⚠ WARNING

Confined Space Hazards!

Do not work in confined spaces where refrigerant or other hazardous, toxic or flammable gas may be leaking. Refrigerant or other gases could displace available oxygen to breathe, causing possible asphyxiation or other serious health risks. Some gases may be flammable and or explosive. If a leak in such spaces is detected, evacuate the area immediately and contact the proper rescue or response authority. Failure to take appropriate precautions or to react properly to such potential hazards could result in death or serious injury.

⚠ WARNING

Explosion Hazard!

Never use an open flame to detect gas leaks. It could result in an explosion. Use a leak test solution for leak testing. Failure to follow recommended safe leak test procedures could result in death or serious injury or equipment or property-only-damage.

Use only dry nitrogen with a pressure regulator for pressurizing unit. Do not use acetylene, oxygen or compressed air or mixtures containing them for pressure testing. Do not use mixtures of a hydrogen containing refrigerant and air above atmospheric pressure for pressure testing as they may become flammable and could result in an explosion. Refrigerant, when used as a trace gas should only be mixed with dry nitrogen for pressurizing units. Failure to follow these recommendations could result in death or serious injury or equipment or property-only damage.

Do not exceed unit nameplate design pressures when leak testing system. Failure to follow these instructions could result in an explosion causing death or serious injury.

Notes:

- All required piping pressure tests must be completed in accordance with national and/or local codes.
 - When leak-testing refrigerant systems, observe all safety precautions.
 - Leak test to 590 psig to minimize system exposure to potentially harmful moisture in the air.
 - Use R-410A refrigerant gas as a tracer for leak detection and use oil-pumped dry nitrogen to develop required test pressures.
1. Close liquid line angle valve.
 2. Connect R-410A refrigerant cylinder to high side charging port (at condenser or field supplied discharge line access port). Add refrigerant to reach pressure of 12 to 15 psig.
 3. Disconnect refrigerant cylinder. Connect dry nitrogen cylinder to high side charging port and increase pressure to 150 psig. Do not exceed high side (discharge) unit nameplate design pressure. Do not subject low side (suction) components to high side pressure.
 4. Check all piping joints, valves, etc. for leaks. Recommend using electronic detector capable of measuring 0.1 oz/year leak rate.
 5. If a leak is located, use proper procedures to remove the refrigerant/nitrogen mixture, break connections and make repairs. Retest for leaks.
 6. Make sure all service valves are open.

Installing the Drain System

1. Push the supplied drain hose as far as possible over the drain hose port.
 - Do not apply excessive force to the piping on the unit side when connecting the drain hose.
 - Drain hose port locations differ depending on the unit type.

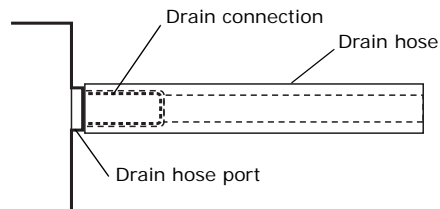

2. Wrap the insulation (supplied) around the drain hose and clamp the connection as tightly as possible until you can see at least 8 holes.
 - Do not apply excessive force to the piping on the unit side when connecting the drain hose.
 - Drain hose port locations differ depending on the unit type.

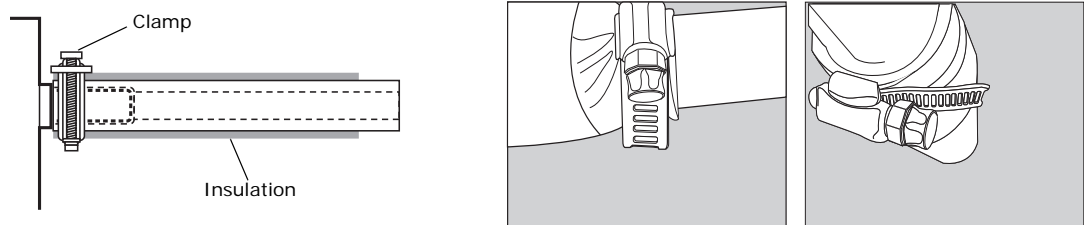

3. Install the drain pipe into the drain hose. Secure it with PVC adhesive and clamps as necessary to ensure a tight fit with no leakage.
 - Do not apply excessive force to the piping on the unit side when connecting the drain hose.
 - Drain hose port locations differ depending on the unit type.

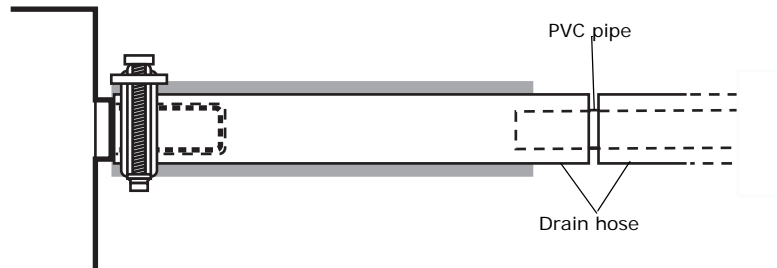

4. Install air vent to ensure smooth condensate drainage.
 - Do not apply excessive force to the piping on the unit side when connecting the drain hose.
 - Drain hose port locations differ depending on the unit type.

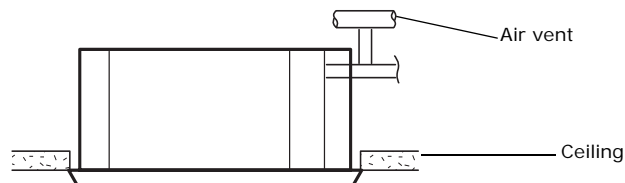

Installation

- Do not install the hose with an upward gradient after the connection port or leaks will result.

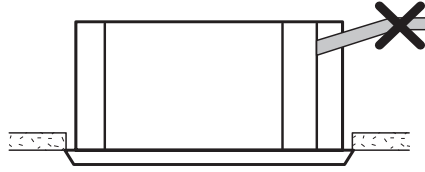

- The hose should not be allowed to hang loose from its connection to the unit. Fasten the hose to a wall, frame or other support as close to the unit as possible.

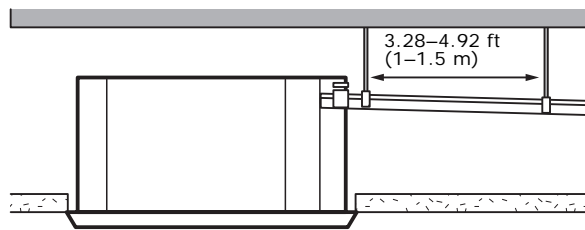

- If increasing the height of the drain pipe is necessary to set the drain hose at a sufficient slope, installing a vertical drain pipe within 11.8 in. (300 mm) from the drain hose port (see A). If raised higher than 21.65 in. (550 mm), water leaks may result (see "C" in figure).
- Install the air vent at least 3.04 in. (100 mm) above the highest point of the drain pipe.

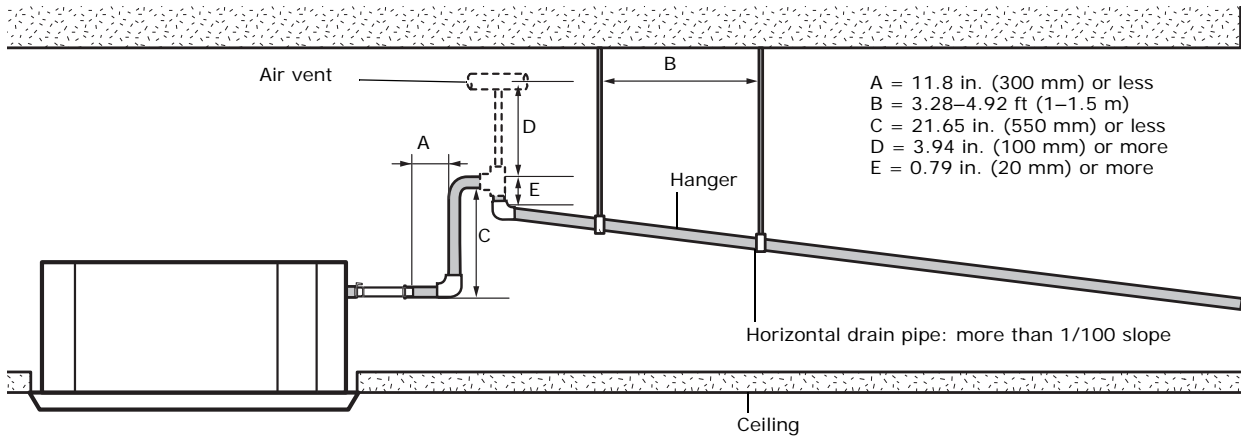

Centralized Drainage

If the installation requires more than three indoor units, install the main air vent at the front of the indoor unit that is farthest from the main drain.

It may be necessary to install individual air vents to prevent water flowing back to each indoor unit. See figure below.

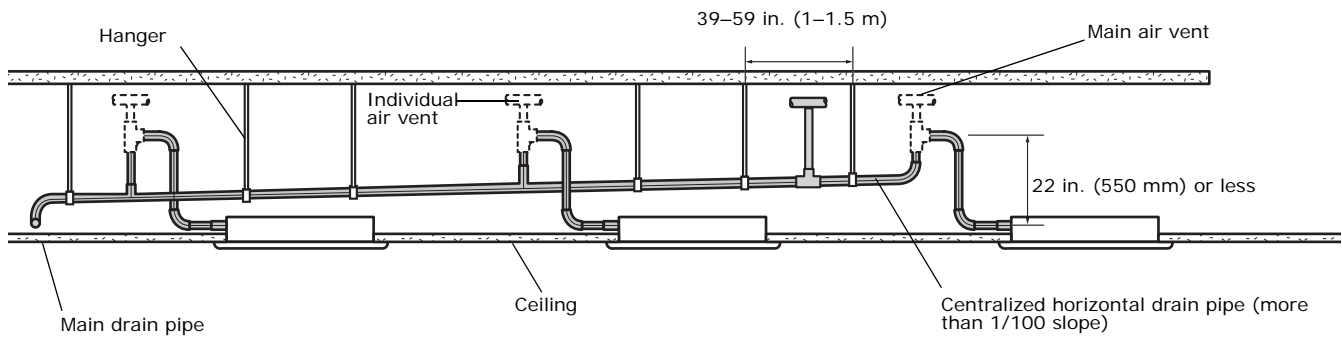

Testing the Drainage

After completing the installation, test the drainage to make sure there are no leaks:

1. Operate the unit in cool mode.
2. Remove drain pump cover.
3. Squirt water into the drain pan (see figure).

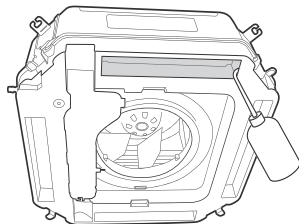

4. Confirm that the water flows out through the drain hose and that no leakage occurs at any of the connections.
5. Reassemble the drain pump cover.

Insulation

After determining that there are no leaks in the refrigerant pipes or drainage hose, insulate them as described in these sections.

Refrigerant Pipes

1. Use the table below to select the insulation type for each pipe size.

Pipe	Pipe size (in. [mm])	Insulation Type	
		Standard conditions (86°F [30°C], 85%)	High humidity conditions ^(a) (86°F [30°C], over 85%)
		EPDM or NBR	
Liquid pipe	1/4 (6.35) – 3/8 (9.52)	3/8 (9)	3/8 (9)
	1/2 (12.70) – 2 (50.80)	1/2 (13)	1/2 (13)
Gas pipe ^(b)	1/4 (6.35)	1/2 (13)	3/4 (19)
	3/8 (9.52) – 1 (25.40)	3/4 (19)	1.0 (25)
	1-1/8 (28.58) – 1-3/4 (44.45)		1-1/4 (32)
	2 (50.80)	1.0 (25)	1-1/2 (38)

- (a) When installing insulation in any of the following environments, use insulation required for high humidity conditions: Buildings with close proximity to bodies of water or hot springs or on the side of a hill in which the building is partly covered by earth; ceilings frequently exposed to moisture such as in restaurants, saunas, swimming pools, and corridors of dormitories or studios near a frequently-used outdoor exit; buildings with no ventilation system.
- (b) Internal temperature of gas pipe is higher than 248°F (120°C).

2. Wrap insulation around the entire surface of each pipe, from the indoor unit to the outdoor unit, overlapping insulation to avoid gaps. Clamp insulation tightly to pipe.

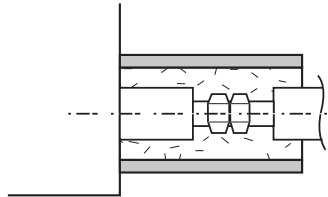

- Do not wrap the gas and liquid refrigerant pipes together.

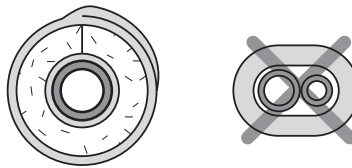

- Avoid compressing the insulation as much as possible.
- Be sure there are no cracks or deformities in the insulation at bends in pipes.
- If necessary double the insulation to prevent condensation from forming in warm or humid areas.
- Cut off excess insulation.

Drainage Hose

Insulate (field supplied) the entire surface of the drain pipe that is inside the building, including the connection between the drain hose and drain stub. Clamp tightly.

Wiring the Unit

Observe the following precautions when making electrical connections.

⚠ WARNING

Hazardous Voltage!

Disconnect all electric power, including remote disconnects before servicing. Follow proper lockout/tagout procedures to ensure the power can not be inadvertently energized. Failure to disconnect power before servicing could result in death or serious injury.

NOTICE

Use Copper Conductors Only!

Unit terminals are not designed to accept other types of conductors. Failure to use copper conductors could result in equipment damage.

- Make all electrical connections in accordance with electrical codes and ordinances.
- Select the power cable in accordance with relevant local and national regulations.
- Wire size must comply with local and national code.
- Use grade H07RN-F or H05RN-F power cable.
- Connect the power cable into the power cable terminal and fasten it with a clamp.
- Unbalanced power must be maintained within 10% of supply rating among whole indoor units.
- Significantly unbalanced power may shorten the life of the system. If the unbalanced power is greater than 10% of supply rating, the unit will stop and an error code will be generated.
- Connect the power cable to the auxiliary circuit breaker. An all-pole disconnection from the power supply must be incorporated in the field wiring (1/8 in. [3 mm]).
- All wiring must be protected from weather and damage.
- Maintain a distance of 2 in. (50 mm) or more between power and communications cables to prevent interference.
- Maintain a voltage drop of less than 10% between the power source and the unit(s).
- Use an appropriate screwdriver for tightening the terminal screws. A screwdriver with a small head will strip the head and make proper tightening impossible.
- Over-tightening the terminal screws may break them.
Tightening torque for M4 screws: 0.86–1.06 lbf·ft (12.0–14.7 kgf·cm).
- After making a knockout hole, apply rust-preventive paint to the bare metal around the hole.
- Secure the cable conduit to the outdoor knockout using the proper connector and bushing.

Power Wiring

Connect the power cable from the outdoor unit to the indoor unit at terminals **L1** and **L2**. Refer to [Figure 1](#) and [Figure 2, p. 18](#).

Communications Wiring

Use 18 AWG, 25 pF/ft nom., 60.7 Ω impedance, braid or foil shielded, twisted pair for communications wiring.

Connect the communications cable from the outdoor unit to the indoor unit at terminals **F1** and **F2**. Refer to [Figure 1](#) and [Figure 2, p. 18](#).

Wiring the Unit

Figure 1. Wiring diagram

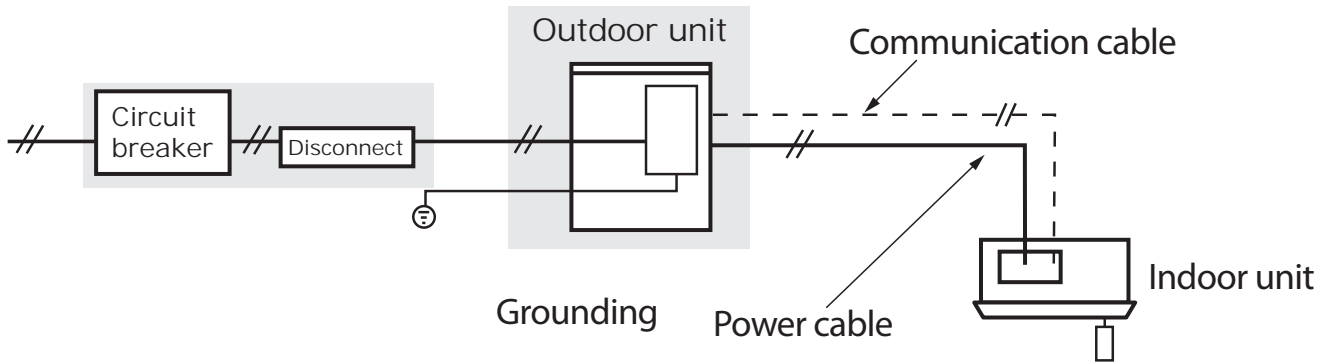
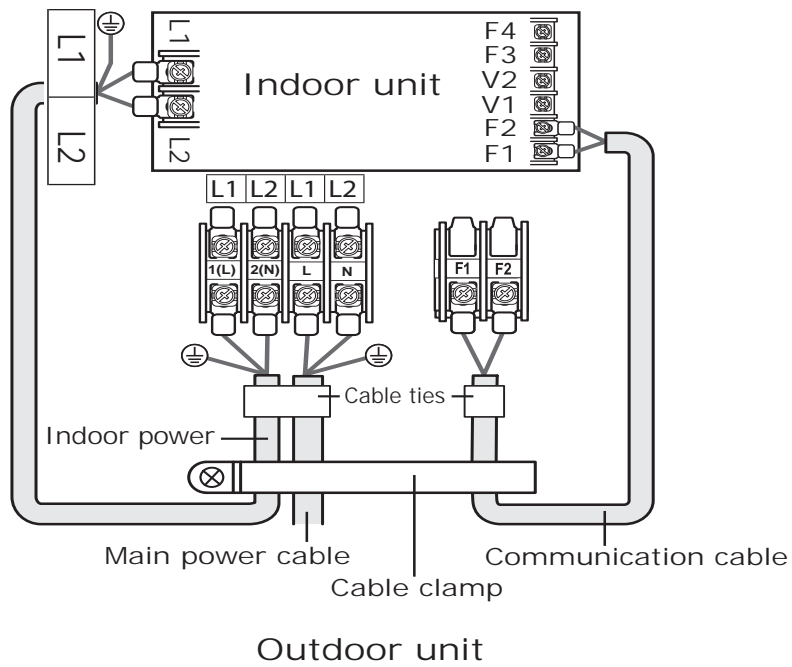

Figure 2. Wiring terminals



Electrical Conduit Installation

A conduit bracket must be installed to secure the conduit, as illustrated in [Figure 3, p. 19](#).

Figure 3. Conduit bracket installation

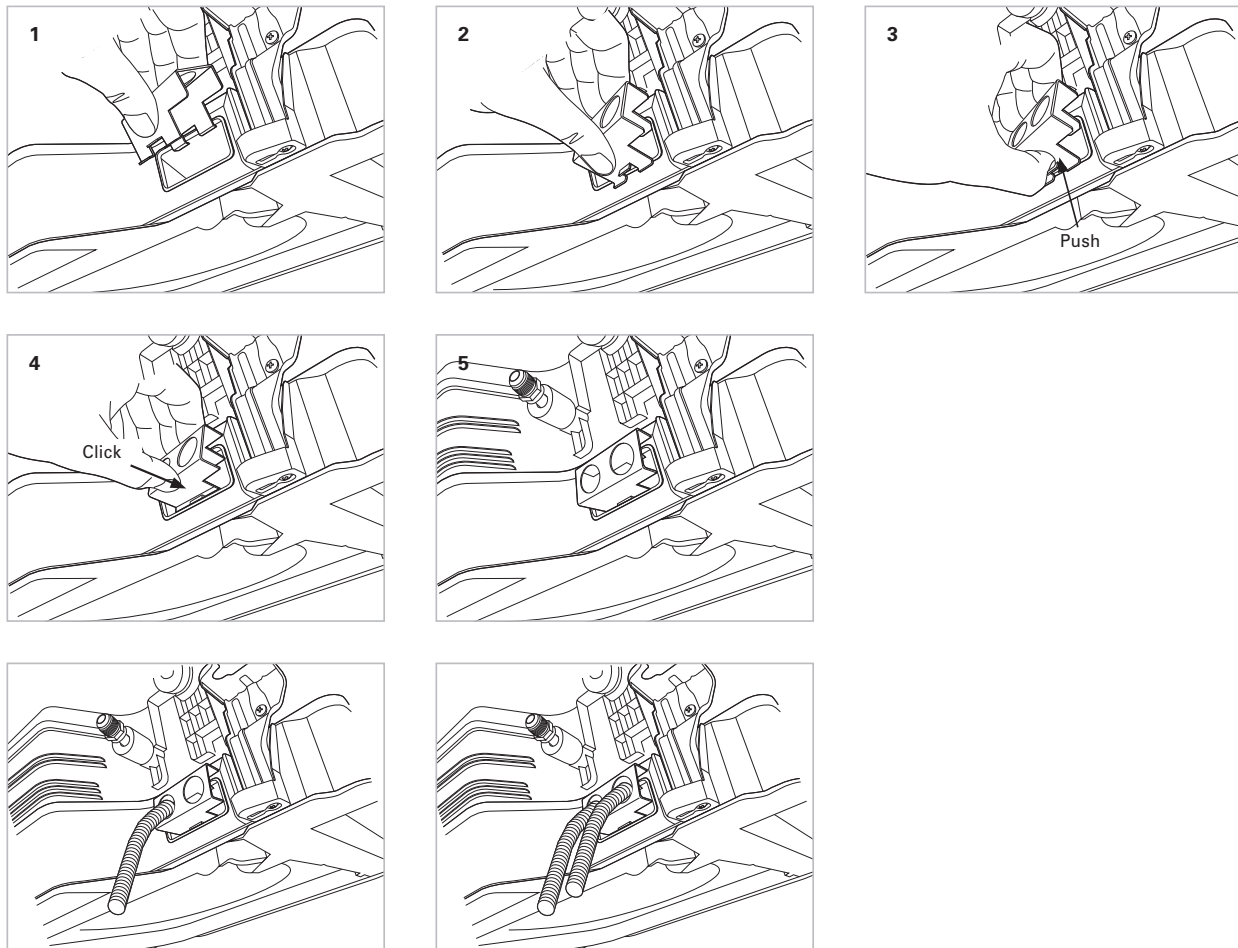

Configuration

All indoor units are factory configured. If modifications are required, The Technician Utilities Tool (TUT) is strongly recommended. However, any of the following devices can be used:

- Technician Utilities Tool (TUT) (instructions follow)
- Wireless Remote Control (instructions follow)
- Wired Remote Control (refer to VRF-SVN59* for instructions)

Note: Configuration changes are not required for typical installations.

Using the Technician Utilities Tool (TUT)

To change configurations using the Technician Utilities Tool (TUT), follow this procedure:

1. At the Indoor Unit Option Writer screen on the TUT, select the desired option codes by referring to [Table 1, p. 23](#).
2. Use the following table and notes to determine which digits can be modified.

Digit	1	2	3	4	5	6	7	8	9	10	11	12
Installation Option #1	[0]	2	0	0	1	0	[1]	0	0	0	0	0

Digit	13	14	15	16	17	18	19	20	21	22	23	24
Installation Option #1	[2]	0	0	0	0	0	[3]	0	0	0	0	0

Notes:

1. Digits 1, 7, 13 and 19 (in brackets) are factory set and cannot be changed.
2. For Installation Option #1, digit 2 will always be "2". See [Table 1, p. 23](#) for the option code settings.
3. Digits shown in black boxes should always be set to "0".

3. To save your settings, select the **Write Option** button. See the figure below for an example of the Indoor Unit Option Writer screen on the TUT.

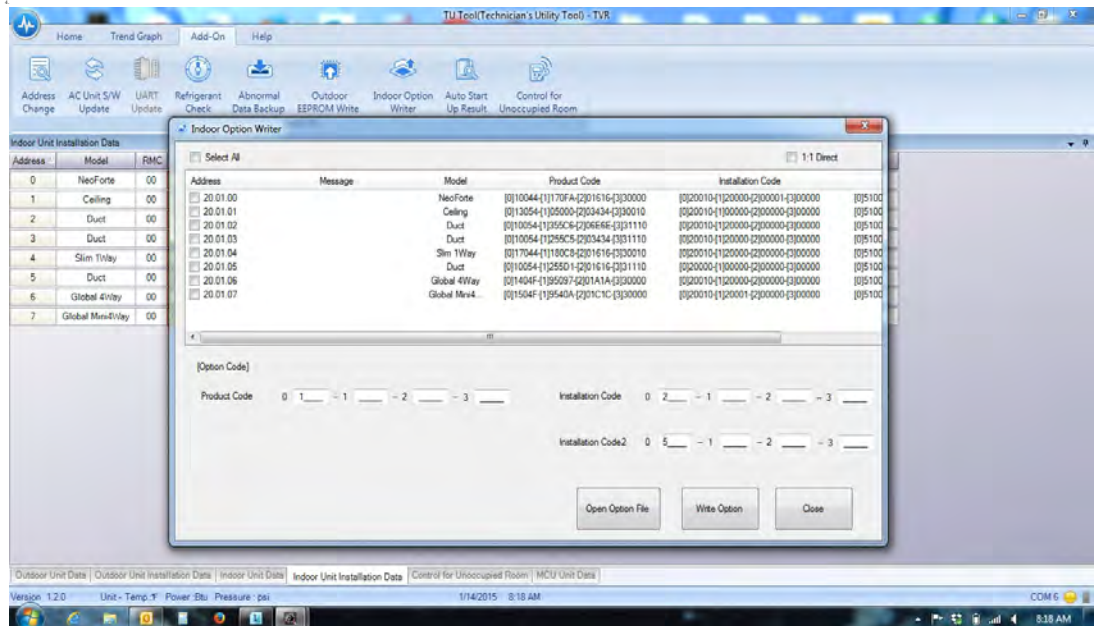

Using the Wireless Remote Control

To change system configurations using the Wireless Remote Control, follow this procedure:

1. Remove the batteries from the remote control, and re-insert them while pressing the Temp+ and Temp- buttons simultaneously (refer to [Figure 4, p. 21](#)).

The first 2-digit segment of a 24-digit sequence will appear on the wireless remote control display, as shown:

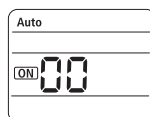

2. To advance to the next 2-digit segment, press the **Mode** button ([Figure 4, p. 21](#)). Continue pressing the **Mode** button until the two-digit segment appears that corresponds to the option setting or address setting you want to view or change.

Each 2-digit segment is differentiated from the others by a combination of operation mode (Auto/Cool/Dry...) and ON/OFF icons, as shown below. (See "The 2-Digit Segments," for more detailed information.)

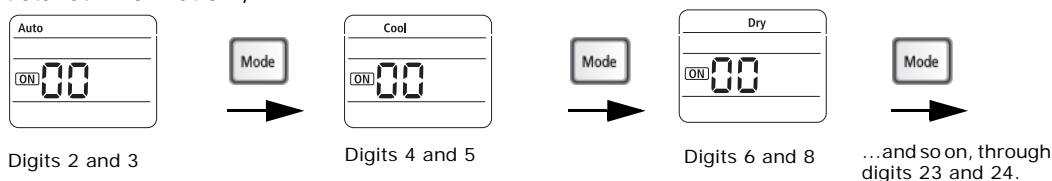

Note: Digits 1, 7, 13, and 19 do not appear and are not used for configuration.

3. To change the value of the left digit on the display, press the **Fan down** button. To change the value of the right digit on the display, press the **Fan up** button.

Note: Values and their corresponding settings are listed in the following pages of this section of the manual.

4. To save the setting, press the **Power** button twice.
5. To restore the wireless remote control to normal operating mode, remove the batteries from the remote control. Then re-insert them.

Figure 4. Wireless Remote Control

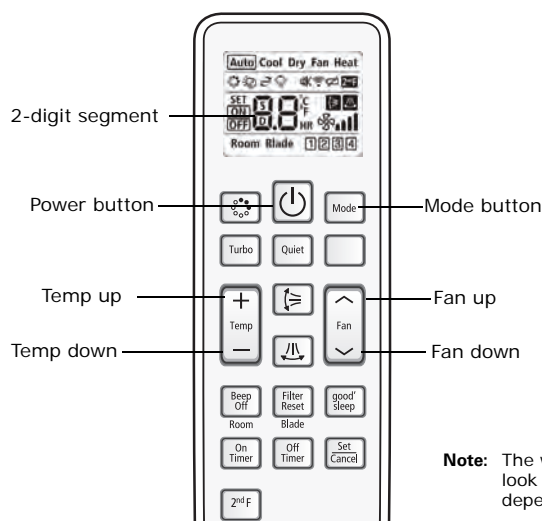

Note: The wireless remote control may look different from the illustration, depending on the model.

The 2-Digit Segments

Each 2-digit segment is differentiated from the others by a combination of operation mode and timer on/off icons as shown in Figure 5.

Use digit 2 (shown in red in Figure 5) to set the wireless remote to Installation Option #1.

Figure 5. Two-digit segments in the 24-digit sequence

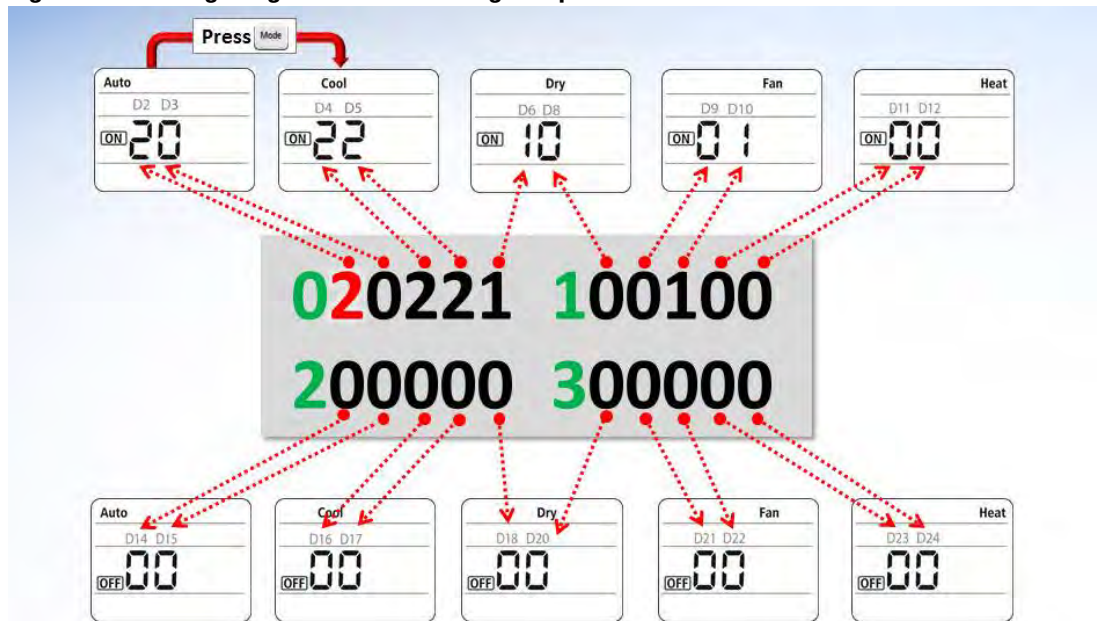

Notes:

1. Digits 1, 7, 13, and 19 (shown in green) are factory set and cannot be changed. They do not appear on the display.
2. Digit 2 (shown in red) is used to set the wireless remote to Installation option #1)
3. The digit numbers shown in gray above each digit (D2, D3, etc.) do not appear on the display.

Installation Option #1

When **digit 2** is set to a value of “2,” the options shown in [Table 1](#) can be set to the values in the right column.

Table 1. Installation option #1: Digit 2 = 2

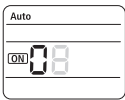
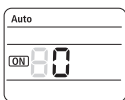
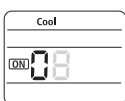
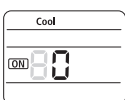
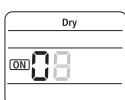
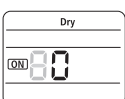
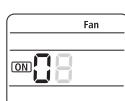
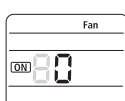
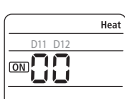
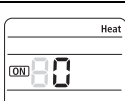
Display screen (mode and On/Off)	Digit	Option description	Set digit to...
N/A	1	Factory set to 0	Cannot be changed. Not seen in configuration mode.
	2	Installation option #1	2
	3	Not available.	Factory set to 0.
	4	Enable only when a remote temperature sensor is used	0: Disabled 1: Enabled
	5	Central control	0: Disabled 1: Enabled
	6	RPM up	0: Disabled 1: Enabled
N/A	7	Factory set to 1	Cannot be changed. Not seen in configuration mode.
	8	Drain pump	0: Disabled 1: Enabled (no delay) 2: Enabled (3-min delay) ^(a)
	9	Not available.	Factory set to 0.
	10	Not available.	Factory set to 0.
	11	Not available.	Factory set to 0.
	12	Master/Slave is automatically designated by wired remote control. ^(b)	0: Slave 1: Master
N/A	13	Factory set to 2	Cannot be changed. Not seen in configuration mode.

Configuration

Table 1. Installation option #1: Digit 2 = 2 (continued)

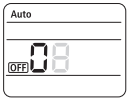
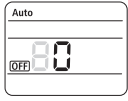
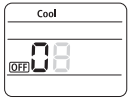
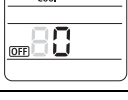
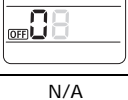
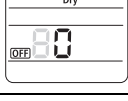
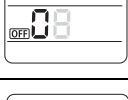
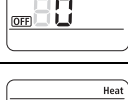
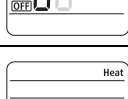
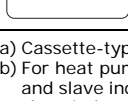
Display screen (mode and On/Off)	Digit	Option description	Set digit to...
	14	External control	0: Disabled 1: On/Off control 2: Off-only control
	15	External control output ^(c)	External control output 0: Thermal on 1: Operation on 2: N/A
	16	Not available.	Factory set to 0.
	17	Buzzer	0: Enabled 1: Disabled
	18	Filter timer (hours of use)	2: 1000 6: 2000
N/A	19	Factory set to 3	Cannot be changed. Not seen in configuration mode.
	20	Associating wireless remote control with indoor unit(s)	0, 1: Channel 1 2: Channel 2 3: Channel 3 4: Channel 4
	21	Heat setting compensation	0: Default 1: 3.6°F (2°C) 2: 9°F (5°C)
	22	Not available.	Factory set to 0.
	23	Not available.	Factory set to 0.
	24	Not available.	Factory set to 0.

(a) Cassette-type indoor units are set to "Enabled (3-minute delay)" regardless of digit 8 setting.

(b) For heat pump systems, the master indoor unit controls whether the system operates in heating or cooling. If the master indoor unit calls for heating and slave indoor units calls for cooling, the master indoor unit (and any other slave indoor units that call for heating) will operate in heating mode. The slave indoor units that call for cooling will do nothing.

(c) Digit 15 requires that an external contact interface module be connected. Refer to VRF-SVN54.

Operation

Familiarize yourself with the unit components and operating tips before operating the unit.

Components

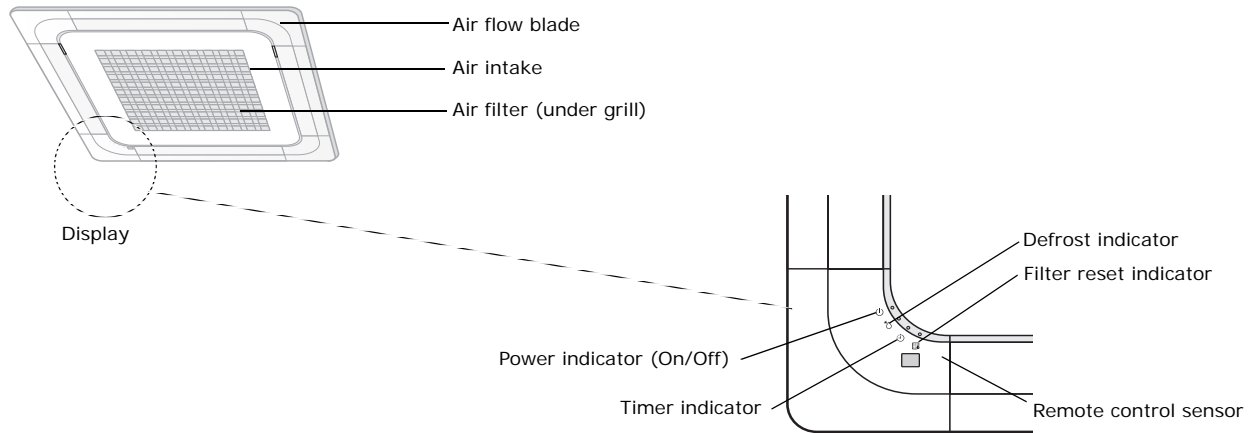

Note: Your unit and display may look slightly different from the illustration shown above, depending on your model.

Operating Tips

Follow these tips when using your unit:

Cooling	If the outside temperature is much higher than the selected indoor temperature, it may take longer than expected to achieve the desired temperature. Avoid making extreme changes in the temperature setting. This practice wastes energy and does not cool the room faster.
Heating	Because the unit heats the room by removing heat energy from outdoor air, the heating capacity may decrease when outdoor temperatures are extremely low. If the unit provides insufficient heat, use an additional heating source in combination with the unit.
Defrost	When the unit runs in Heat mode, frost may form due to the temperature difference between the unit and the outside air. If this happens: <ul style="list-style-type: none"> • The unit stops heating. • The unit will operate automatically in Defrost mode for 10 minutes. • The steam produced on the outdoor unit in Defrost mode is safe. No intervention is required; after about 10 minutes, the unit will resume normal operation. The unit will not operate when it starts to defrost.
Fan	The fan may not operate for 3–5 minutes after turning on the unit, to prevent cold air from blowing on occupants while the unit is warming up.
High indoor and outdoor temperatures	If both indoor and outdoor temperatures are high and the unit is running in Heat mode, the outdoor unit fan and compressor may stop at times. This is normal; wait until the unit turns on again.
Power failure	A power failure will cause the unit to stop operating. When power returns, the unit will automatically resume operation.
Minimum Off Timer	If the unit has just been turned on, it will not produce cool/warm air for 3 minutes. This delay mechanism protects the outdoor unit compressor.

Internal Protections

Internal protections operate if an internal fault occurs in the unit.

Type	Description
Cold air dump	The internal fan will be off to prevent a cold air dump when the heat pump is in defrost mode.
Defrost cycle	The internal fan will be off to prevent a cold air dump when the heat pump is in defrost mode.
Anti-short cycle timer	The compressor observes a 3-minute off time when cycling power to the unit or after an outage.

Note: If the heat pump is operating in Heat mode, a defrost cycle is activated to remove frost from an outdoor unit that may have accumulated at low temperatures. The internal fan is switched off automatically and restarted only after the defrost cycle is completed.

Operating Ranges

For efficient use, operate the unit within the ranges shown in this table.

Mode	Outdoor temperature	Indoor temperature	Indoor humidity
Cooling ^{(a), (b)}	0°F (-18°C) to 115°F (46°C)	64°F (18°C) to 90°F (32°C)	80% or less
Heating ^(c)	-4°F (-20°C) to 75°F (24°C)	81°F (27°C) or less	—
Drying	0°F (-18°C) to 115°F (46°C)	64°F (18°C) to 90°F (32°C)	—

(a) If the indoor cooling temperature is set higher than 90°F (32°C), the unit will not cool to its full capacity.

(b) If cooling is set below 23°F (-5°C), a wind baffle is required. See MS-SVN045* for wind baffle installation information.

(c) The standard temperature for heating is 45°F (7°C). If the outdoor temperature drops to 32°F (0°C) or below, the heating capacity can be reduced depending on the temperature condition.

Cleaning the Exterior

Use a dry or damp cloth to wipe the surface of the unit as needed. If necessary, use mild soap and water on a damp cloth. Use a soft brush to remove dirt from the grill.

NOTICE

Avoid equipment damage and risk of fire!

Avoid using benzene or other flammable solvents. They may damage the surface of the unit and increase the potential for fire.

Cleaning the Grill and Air Filter

1. Open the blades on the left and right sides of the grill. Press both levers and pull the grill downward. Two safety clips are mounted to the grill to prevent it from dropping.

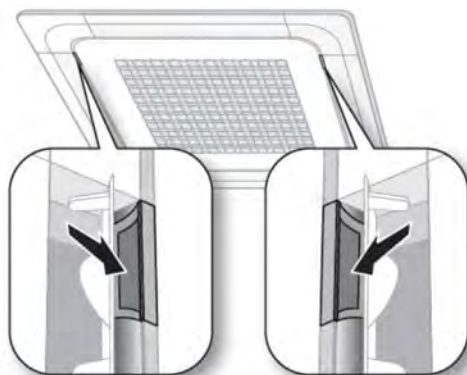

2. Detach the grill by first removing the safety clip and then removing the hinge. Pull the green switch on the hinge part down and then press and pull the hinge part to remove the grill. (There are two hinges on the grill which must both be removed by the same procedure.)

To clean only the filter, proceed to step 4.

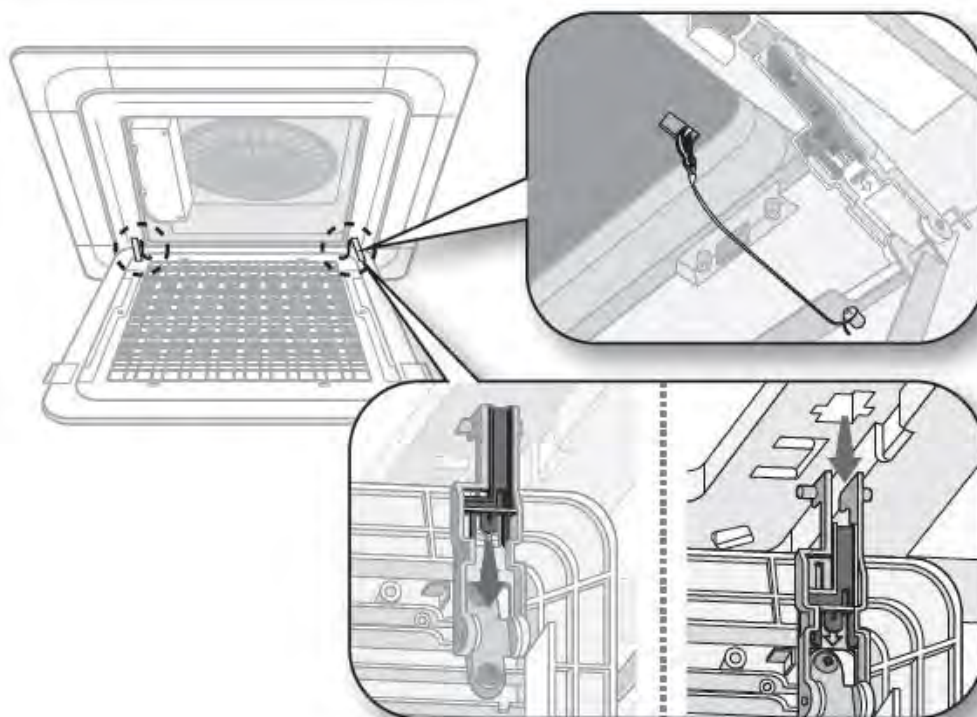

3. Pull out the air filter.

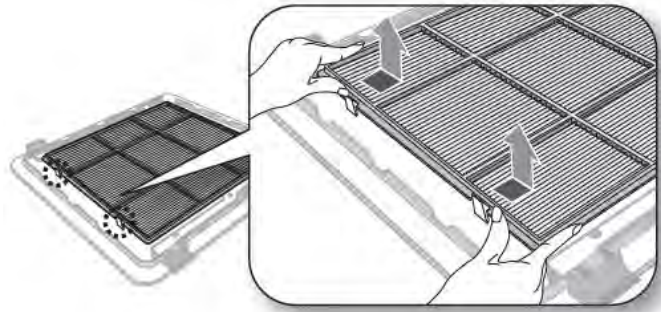

4. Clean the grill and air filter with a vacuum or soft brush. If the dust is too thick, rinse them under running water and dry in a well-ventilated area.
Note: Drying the air filter in a confined or humid area may cause odors to develop. If odors occur, re-clean and dry it in a well-ventilated area.
5. Replace the air filter in its original position. The air filter will click when it is in the proper position.
6. After cleaning the air filter, press the Filter Reset button on the remote control for 2 seconds to reset the filter schedule. The filter indicator lights when it is time to clean the filter again.
7. Replace the grill by reversing the first three steps.
Note: If the angle on the air flow blades changed as a result of opening the grill, cycle power to the unit to restore the blades to their proper angle.

Periodic Maintenance Checks

Refer to the schedule given in [Table 2](#) for proper unit maintenance.

Note: If the unit will not be used for an extended period of time, operate it in Fan mode for 3–4 hours to thoroughly dry it and then disconnect the power plug. Moisture left in the components can cause odors and internal damage.

Table 2. Maintenance schedule

Description	Monthly	Every 4 months	Once a year	As needed
Clean the air filter ^(a)	x			
Clean the condensate drain pan ^(b)			x	
Thoroughly clean the heat exchanger ^(b)			x	
Clean the condensate drain pipe ^(b)		x		
Replace remote control batteries ^(a)				x

(a) The described operations should be performed more frequently if the area of installation is very dusty.

(b) These operations must always be performed by qualified personnel. For more detailed information, see the installation manual for this unit.

Troubleshooting

Refer to [Table 3](#) for solutions to common problems and to [Table 4, p. 30](#) for a list of alarm conditions with corresponding error codes and LED behavior.





Table 3. Solutions to common problems

Problem	Solution
The unit does not operate immediately after restarting it.	The anti-short cycle timer prevents the unit from operating immediately to keep it from overloading. The unit will start in 3 minutes.
The unit does not operate.	Verify the following: The power plug is properly inserted into the wall receptacle. There has not been a power failure. The circuit breaker is switched on/fuses are good.
The temperature does not change.	Verify that the unit is not operating in Fan mode. If it is, select a different mode.
The unit is not producing warm/cool air.	Verify the following: Temperature setting on remote control is higher/lower than the current temperature. Air filter is not clogged with dirt. If the unit has just been turned on, wait 3 minutes for the anti-short cycle timer to expire. Air flow is unobstructed. Line size and length is correct and does not exceed factory recommendations. Operating mode is heat/cool. If unit is not producing warm air, is it set to Cool mode? Remote control is not for a cooling-only unit. That the unit has not been installed in direct sunlight. If so, hang curtains or shades on windows to filter the sun and increase unit efficiency.
The fan speed does not change.	Verify that Auto or Dry mode is selected. Either of these modes automatically adjust the fan speed.
Timer function does not work.	Press the Power button on the remote control after setting the time.
Odors permeate the room during operation.	Verify the origin of the odor. Operate the unit in Fan mode or open the windows to air out the room.
The unit makes a bubbling sound	A bubbling sound may be heard when the refrigerant is circulating through the indoor unit during certain system operating conditions, which should normally be of short duration.
Water is dripping from the air flow blades.	If the unit has been running for an extended period of time with the blades fully open, adjust the blades to mid-position to alleviate condensation formation.
The remote control is not working.	Verify that: Batteries are not depleted. Batteries are correctly installed. Nothing is blocking the remote control sensor. No strong fluorescent or neon lighting is near the unit, which may interrupt the signal.
The unit does not turn on/off with the wired remote control.	Ensure that the wired remote control is not set for Group Control.
Indicators on the digital display flash.	Press the Power button on the remote control to turn the unit off. Then switch the circuit break off and then on again.

Troubleshooting

If an error occurs, one of more of the LEDs on the display (see “Components” for their location) will flicker. As a protection strategy, the unit stops operating (and the LED turns off). If the unit is turned on before the problem is resolved, the LED will resume flickering and the unit will stop operating again.

Table 4. Diagnostic LEDs for the C-series 4-way cassette indoor unit

Alarm condition	LED display			
	Power 	Defrost 	Timer 	Filter 
Indoor temperature sensor error (shorted or open)	Off	Flickering	Off	Off
EVA-IN, EVA-OUT sensor error (shorted or open)	Flickering	Flickering	Off	Off
Indoor fan error	Off	Off	Flickering	Off
Outdoor temperature sensor error (shorted or open)	Flickering	Off	Flickering	Off
No communication between indoor and outdoor units for 2 minutes	Off	Flickering	Flickering	Off
Outdoor unit error/Self-diagnosis (check error code at outdoor unit)	Off	Flickering	Flickering	Flickering
Float switch detection	Off	Off	Flickering	Flickering
EEPROM error/EEPROM option error	Flickering	Flickering	Flickering	Flickering
High-pressure blockage error	Flickering	Off	Flickering	Flickering

Note: If the indoor unit is turned off, the LED also turns off.

Table 5. Error codes for the C-series 4-way cassette indoor unit

Error code	Explanation	Remarks
416	Compressor down due to protection control of the discharge temperature sensor	Outdoor unit protection control
450	Error due to condenser temperature sensor when in cooling mode	
451	Error of the low pressure switch (Protection control)	
425	Reverse phase error (Protection control)	
551	In removing frost	
221	Error of outdoor temperature sensor (Open/Short)	Outdoor unit sensor error (Open/ Short) Detection during indoor unit operation (sensing and sending errors into the communication data)
237	Error of condenser temperature sensor (Open/Short)	
251	Error of discharge temperature sensor (Open/Short)	
201	System down caused by communication error after completion of tracking Mismatching of indoor unit quantity setting error after completion of tracking 5 times	Communication and indoor unit errors
121	Error of temperature sensor in the indoor unit (Open/Short)	Self-diagnosis of the indoor and outdoor unit
122	Error of the heat exchanger sensor in the indoor unit (Open/Short)	
419	Error of electronic expansion valve open in the outdoor unit (when it is detected more than once)	
422	Error of electronic expansion valve close in the outdoor unit (when it is detected more than once)	Wired remote control errors
601	Error of communication between the indoor unit and the wired remote controller	
602	Master wired remote controller / slave wired remote controller	
606	Polarity error (F1/F2, F3/F4 switched)	
EA	Error of setting option for wired remote controller COM2	

Warranty For Trane C-Series Ductless Systems and Related Accessories

Products Covered

This warranty is extended by Trane, and applies to all Trane C-Series Ductless Systems and Accessories for these products which are sold by Trane and applied in accordance with Trane specifications.

Basic Warranty

The warrantor warrants for a period of 5 years from the initial start-up or 5 years and 6 months from date of shipment, whichever is less, against failure due to defects in material and manufacture and that it has the capacities and ratings set forth in Company's catalogs and bulletins ("Warranty").

If any part of your C-Series Ductless System fails because of a manufacturing defect under normal use and maintenance within the Limited Warranty Period, the Company will furnish the required replacement part. If the compressor, outdoor coil or indoor coil should be the part that fails during the Limited Warranty Period, the affected unit will be replaced. The purchaser must pay for any and all shipping and handling charges and other costs of warranty service for the replacement part including, but not limited to, any related service labor, diagnosis calls and refrigerant.

Exclusions and Limitations

Exclusions from this Warranty include damage or failure arising from: wear and tear; corrosion, erosion, deterioration; modifications made by others to the Equipment; repairs or alterations by a party other than Company that adversely affects the stability or reliability of the Equipment; vandalism; neglect; accident; adverse weather or environmental conditions; abuse or improper use; improper installation; commissioning by a party other than Company; unusual physical or electrical or mechanical stress; operation with any accessory, equipment or part not specifically approved by Company; refrigerant not supplied by Company; and/or lack of proper maintenance as recommended by Company. Company shall not be obligated to pay for the cost of lost refrigerant or lost product. Company's obligations and liabilities under this Warranty are limited to furnishing replacement equipment or parts, at its option, FCA (Incoterms 2000) factory or warehouse (f.o.b. factory or warehouse for US domestic purposes) at Company-designated shipping point, freight-allowed to Company's warranty agent's stock location, for all non-conforming Company-manufactured Equipment (which have been returned by Customer to Company. Returns must have prior written approval by Company and are subject to restocking charge where applicable. Equipment, material and/or parts that are not manufactured by Company are not warranted by Company and have such warranties as may be extended by the respective manufacturer. **COMPANY MAKES NO REPRESENTATION OR WARRANTY, EXPRESS OR IMPLIED, REGARDING PREVENTION OF MOLD/MOULD, FUNGUS, BACTERIA, MICROBIAL GROWTH, OR ANY OTHER CONTAMINATES.** No warranty liability whatsoever shall attach to Company until Customer's complete order has been paid for in full and Company's liability under this Warranty shall be limited to the purchase price of the Equipment shown to be defective. EXCEPT FOR COMPANY'S WARRANTY EXPRESSLY SET FORTH HEREIN, COMPANY DOES NOT MAKE, AND HEREBY EXPRESSLY DISCLAIMS, ANY WARRANTIES, EXPRESS OR IMPLIED CONCERNING ITS PRODUCTS, EQUIPMENT OR SERVICES, INCLUDING, WITHOUT LIMITATION, ANY WARRANTY OF DESIGN, MERCHANTABILITY OR OF FITNESS FOR A PARTICULAR PURPOSE, OR OTHERS THAT ARE ALLEGED TO ARISE FROM COURSE OF DEALING OR TRADE.

Additional warranty protection is available on an extra-cost basis and must be in writing and agreed to by an authorized signatory of the Company. Additional terms and conditions of warranty coverage are applicable for refrigeration equipment. If you wish further help or information concerning this warranty, contact: Trane—Warrantor, 2701 Wilma Rudolph Blvd., Clarksville, TN. 37040.

The manufacturer optimizes the performance of homes and buildings around the world. A business of Ingersoll Rand, the leader in creating and sustaining safe, comfortable and energy efficient environments, the manufacturer offers a broad portfolio of advanced controls and HVAC systems, comprehensive building services, and parts. For more information, visit www.IRCO.com.

The manufacturer has a policy of continuous product and product data improvement and reserves the right to change design and specifications without notice.